

Henry Williams Ltd.
Darlington
Co. Durham
DL1 2NJ
(01325) 462 722

www.hwilliams.co.uk



Class II FSP Modules

Operation & Maintenance Manual

Document Ref: HWC2Mod1: Version 1.2



SIEMENS



Issue and Revision Record

Rev	Date	Originator (Print) (Signature)	Checker (Print) (Signature)	Description
1.0	10/11/17	D Hughes	C Stephenson	First Issue
1.1	21/08/19	D Hughes	C Stephenson	Drawing Refs updated
1.2	16/10/20	P Davies	C Stephenson	Models Updated

List of Contents

Chapters and Appendices

Table of Figures	4
1 Introduction	5
1.1 Maintenance Policy	5
1.1.1 Complete Replacement	5
1.1.2 Component Repair	5
1.2 Competencies and Training Requirements	6
1.3 Glossary of Terms and Abbreviations	6
1.4 Drawing References	7
2 Safety	8
2.1 Isolation and Risk of Electrocution	8
2.2 Class II Coating	8
2.3 Class II Definition	8
2.4 Lifting & Trapping	9
2.5 Disposal of Equipment	9
2.6 Fuse Ratings	10
2.7 Fault Conditions Required for Electric Shock	10
3 Details of the Class II FSP Modules Equipment	11
3.1 General Information	11
3.2 Outgoing/Functional Circuits Configuration	11
3.3 The FSP Class II Modules Layout/General Arrangement	12
4 Installation (First fit – with Power OFF)	15
4.1 Installation of Internal Hybrid Transformer Primary Circuits Wiring	22
4.2 Installation of Functional Load Circuits (650V) External Wiring	23
4.2.1 Terminals for Functional Load Circuits (650V) External Wiring	25
4.3 Replacement of Incoming or Outgoing Loop Power Cables (Under Operational Conditions)	26
4.4 Cable Glands & Insulated Reducers	30
5 Maintenance	32
5.1 Replacement of Components	32
5.2 Annual Procedure	32

5.3 EIC Coating Damage Guidance	33
6 Part Numbers	35

Table of Figures

Figure 1: Warrior M200 Manual elevator platform	9
Figure 2: FSP Front Module Layout Arrangement	12
Figure 3: FSP Rear Module (4 Output) Layout Arrangement	13
Figure 4: FSP Rear Module (4 Output) Functional Supply Terminals	13
Figure 5: Power In/Out Terminal Arrangement	14
Figure 6: Measure & Strip Cable	16
Figure 7: Fit Shroud followed by Gland onto Stripped Cable	16
Figure 8: Installed Cable into removed Gland Plate	17
Figure 9: Forming Cable V shape	17
Figure 10: Cable length marked ready for cutting	18
Figure 11: Cable cut to length	18
Figure 12: Rounding Cable ends using tool	19
Figure 13: Orientation of crimp lugs with the terminal studs	19
Figure 14: Crimping Cable Lugs	20
Figure 15: Tape crimps & terminate cable	20
Figure 16: Final installation of terminated cables	21
Figure 17: Termination of Hybrid Transformer Primary Feed Cables	23
Figure 18: Termination of External Loads Feed Cable	24
Figure 19: Ring Cable Diagram	27
Figure 20: Insulated Reducers & Cable Glands	31
Figure 21: EIC Damage Guide	34

1 Introduction

This document is designed for use by the technical installation staff. It is primarily for use in the installation of the Class II front and rear modules into an external railway type enclosure.

Throughout this document, references will be made to other essential information and documentation either prepared by HWL or provided from the equipment supplier/manufacturer.

After safety issues are discussed in Chapter 2 this manual follows a logical path from Description of the relevant components, equipment installation, repair/replacement, routine maintenance and finally a spare parts listing.

- **Chapter 2 Safety**
Gives details of any relevant safety issues to be observed in the use and disposal of the equipment.
- **Chapter 3 Details of FSP Equipment**
Gives details of the FSP Class II modules enclosures and equipment.
- **Chapter 4 FSP Installation**
Gives details on installation of the equipment and the power cables.
- **Chapter 5 Maintenance**
Details the recommended maintenance checks required to ensure the ongoing correct operation of the system.
- **Chapter 6 Part Numbers**
Lists the main parts of the FSP Modules complete with Supplier and Part numbers to aid in the re-ordering of spare parts.

1.1 Maintenance Policy

The FSP modules system comprises highly reliable components. However should a fault occur, the unit can be completely replaced or repaired.

1.1.1 Complete Replacement

If any of the FSP modules are completely replaced, note the following:

Note that these are insulated Class II units and must only be replaced by identical Class II units.

1.1.2 Component Repair

Repair of the box is assumed to be limited to replacement of either failed components or wiring replacement as necessary.

To summarise, the maintenance policy is one of “Repair by Replacement” since:

- Internal components are relatively inexpensive with respect to the cost of fault diagnosis and repair.
- Most internal components are interchangeable although some disassembly will be required for access.

1.2 Competencies and Training Requirements

Staff with the responsibility for installation and maintenance of these modules must hold the required training and/or Network Rail licenses.

The training will provide the skills and knowledge needed to identify faulty modules/components and the correct procedures for their replacement. Training for the repair of line replaceable units (modules) is not available. Line replaceable units, where appropriate will be returned to the manufacturer for repair or replaced from spares where repair is not practical.

1.3 Glossary of Terms and Abbreviations

EIC	Electrically Insulated Coating
Class II	See definition in Section 2.3
FSP	Functional Supply Point
HWL	Henry Williams Limited
Loc	Location/Location Case
mm	millimetres
REB	Relocatable Equipment Building
VAC	Voltage (AC) Alternating Current

1.4 Drawing References

Class II Module	Wiring Schematic Drawing Ref.	General Assembly Drawing Ref.
FSP (Front) with ARS	24104-FSPFARS	2018.011-A1-001
FSP (Front) without ARS	24104-FSPF	2018.011-A1-500
FSP (Front) Services Distribution Enclosure	24104-FSPFS	Shown on above Front Assembly Drawings
FSP (Rear) 2 Functional Supplies	24104-FSP2FS	2018.013-A1-001
FSP (Rear) 4 Functional Supplies – Tunnel Terminals	24104-FSP4FS	2018.012-A1-001
FSP (Rear) 4 Functional Supplies – Stud Terminals	24104-FSP4FSREB	2018.078-A1-001
FSP (Rear) 1 Functional Supply – Spur Module	24104-FSPSPM1	2018.014-A1-001

Copies of the above drawings are available from:

Henry Williams Ltd.

Telephone: (01325) 462 722

Email: sales@hwilliams.co.uk

2 Safety

2.1 Isolation and Risk of Electrocutation

These units are designed to work with voltages up to (and including) 650VAC and as such there is a danger of electrocution once any of the covers are removed.

All electrical power feeds to these units MUST be ISOLATED and LOCKED OFF BEFORE opening any doors or removal of any of the enclosure covers.

A 650VAC supply voltage is commonly used inside power & signalling cubicles, therefore any personnel working inside these units should be appropriately trained. It should also be noted that these Class II FSP Modules are mounted inside a locked enclosure, which also have large caution labels clearly visible from the front.

Personnel working on any of these units should be appropriately trained to work with dangerous voltages and be fully conversant with the power circuitry. All connections are shrouded to prevent accidental contact with personnel (fingers etc.) however voltages may be exposed when using tools such as screwdrivers etc.

Once Isolation has been carried out, it is essential that a proved* voltage indicator is used to recheck that all electrical equipment is dead prior to any works being undertaken.

* It is recommended to use a proving device with the voltage indicator to check for correct operation both before and after checking that the equipment to be worked upon is dead.

2.2 Class II Coating

The product is coated with a special Electrically Insulated Coating (EIC) which can withstand very high voltages. This coating must remain intact in order to ensure the integrity of the insulation properties of the enclosure. There must therefore be no further holes or other cut-outs made into the enclosure body post manufacture.

2.3 Class II Definition

A Class II or double insulated electrical appliance is one which has been designed in such a way that it does not require a safety connection to electrical earth.

The basic requirement is that no single failure can result in dangerous voltage becoming exposed so that it might cause an electric shock and that this is achieved without relying on an earthed metal casing.

This is usually achieved at least in part by having two layers of insulating material surrounding live parts or by using reinforced insulation.

2.4 Lifting & Trapping

These units can be very heavy (approx. 40Kg depending upon module) and extra care should be exercised when handling these units.

It is recommended that a mobile lifting platform be used in order to elevate and position each module into the case. This will take the weight of the unit whilst the fixing holes are being aligned to the unistrut fixings within the FSP outer case.

A typical lifting platform is shown in Figure 1.



Figure 1: Warrior M200 Manual elevator platform

The Manual Handling Regulations should be taken into account when lifting heavy items.

2.5 Disposal of Equipment

Due consideration must be given when disposing of equipment.

Environmental regulations and standards are continually being updated and therefore a risk assessment must be undertaken at the time of equipment disposal.

None of these components contain batteries or magnets.

Although the Class II coating and other materials used in the equipment are designed to release low smoke and less toxic fumes when burnt; burning of this equipment, as a means of disposal is not appropriate.

The equipment must be disposed of in accordance with the Waste Electrical and Electronic Equipment (WEEE) Regulations. Further information is available on the following website: <http://www.hse.gov.uk/waste/waste-electrical.htm>.

2.6 Fuse Ratings

All fuses installed into the fuse carriers must be rated to a minimum of 690VAC.

2.7 Fault Conditions Required for Electric Shock

Note that in order for a person to receive an electric shock (with the main enclosure doors open but the internal enclosure doors/covers closed) the following simultaneous fault conditions must exist:

- The outer coating must be penetrated/damaged (at least to bare metal).
- The inner coating must be penetrated/damaged (at least to bare metal).
- An internal electrical fault must occur so that a live conductor touches exactly the same area where the inner coating is exposed to bare metal.
- The person must make contact with exactly the same area where the outer coating is exposed to bare metal.

3 Details of the Class II FSP Modules Equipment

3.1 General Information

This equipment is a Class II 650VAC distribution system designed to meet the requirements of Network Rail specification NR/L2/ELP/27409 “Product Specification for Functional Supply Points (FSP)”.

These modules can be used in the following distribution topologies:

- FSP01 – Single end fed – Radial
- FSP02 – Dual end fed – Manually Reconfigurable
- FSP03 – Dual end fed – Automatically Reconfigurable

The equipment consists of two separate insulated enclosures mounted within an external railway type enclosure. Each of these enclosures contains independent sections which are fitted with the required switchgear.

Generally, the front enclosure contains the incoming, bypass, & distribution switching arrangements. The rear section contains the outgoing distribution switches & terminals for the functional circuits.

The front module is designed to be the unit which will terminate the incoming and outgoing 650VAC power loop cables. This is achieved using two independent gland plates with main terminals for the conductors of each power cable.

The unit is designed so that the incoming and outgoing loop feeder cable terminals are housed in separate compartments. This allows one cable to be isolated and safely worked on whilst the other is still live and powering the location signalling equipment.

The enclosures are manufactured from stainless steel which is completely covered in a special Electrically Insulated Coating (EIC). This insulation gives the enclosure its Class II protection properties.

3.2 Outgoing/Functional Circuits Configuration

There are three independent class II modules which have been designed for the distribution of the functional supplies. These are a 2-way, and a 4-way module (tunnel terminal & stud terminal variants) which can be installed into the rear of the railway equipment case. The modules can be installed as required to make a quantity of 2, 4, 6, or 8 internal transformers/rectifiers or external circuits.

There is also a rear SPUR module which is designed for outgoing supply cables up to 120mm². This module is one way, and has M10 stud connections for large lugged cables.

Each independent Functional Supplies Output module houses an isolation switch and pair of fuse holders for each functional supply way.

The outgoing functional circuit ways, not used to feed transformers within the FSP may be used to feed cables to other loads (location cases) external to the FSP.

3.3 The FSP Class II Modules Layout/General Arrangement

The photographs below show the general layouts of the front and rear FSP modules. The general layout of the rear will be the same but may have more or less functional outputs.

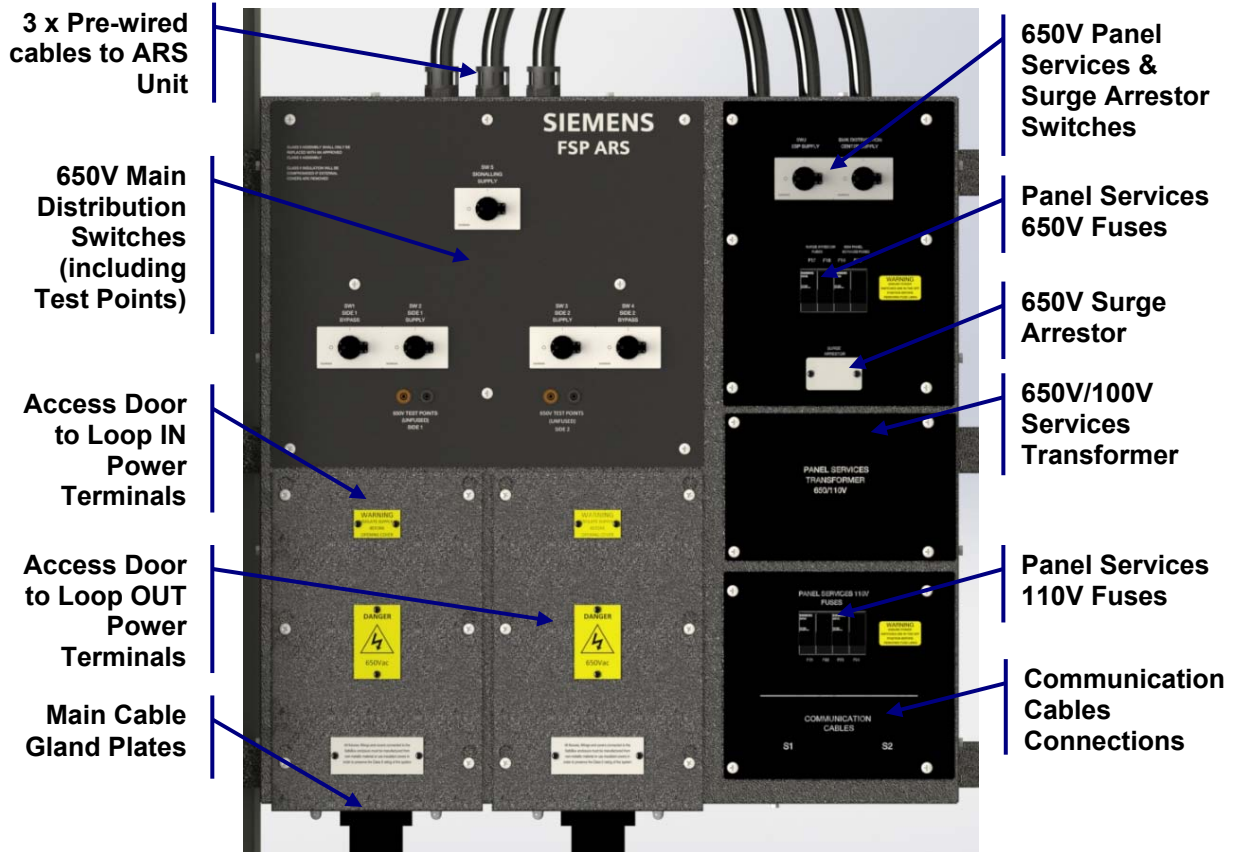

Figure 2: FSP Front Module Layout Arrangement

Figure 2 shows the general layout arrangement of the front (incoming) side applicable to the FSP module.

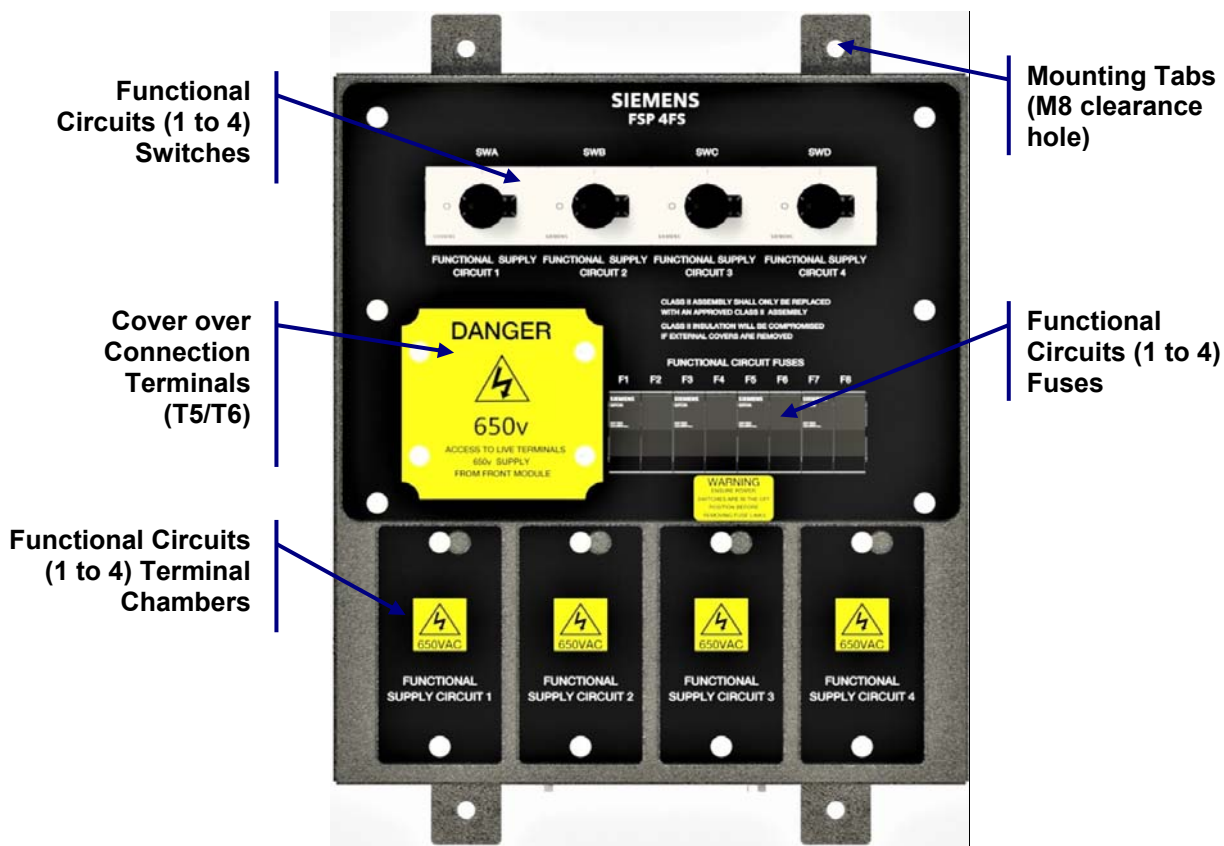

Figure 3: FSP Rear Module (4 Output) Layout Arrangement

Figure 3 shows the general layout of the rear (4 Output) side of the FSP module. Figure 4 shows the functional circuits terminals under the swing covers.

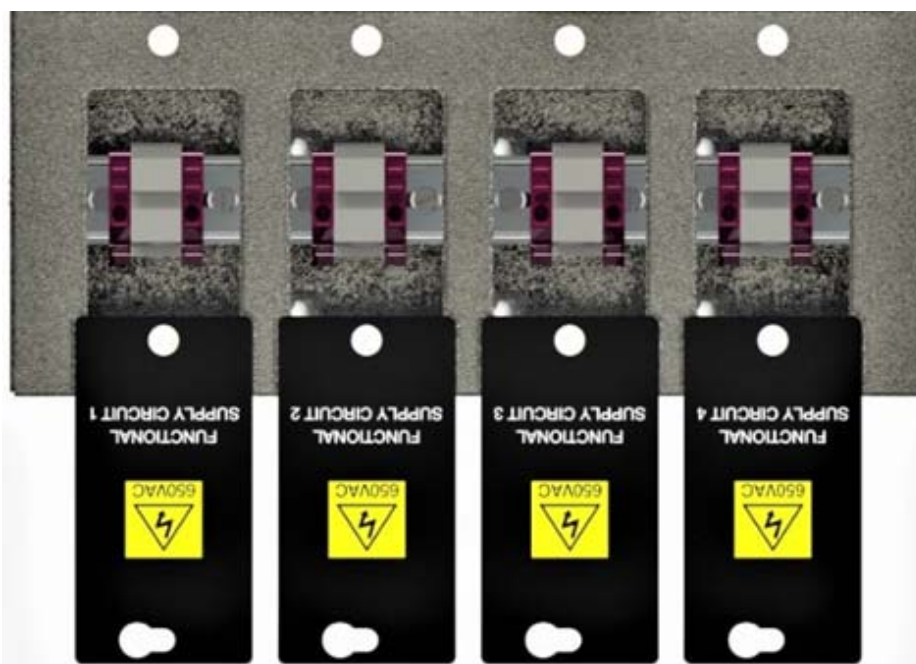

Figure 4: FSP Rear Module (4 Output) Functional Supply Terminals

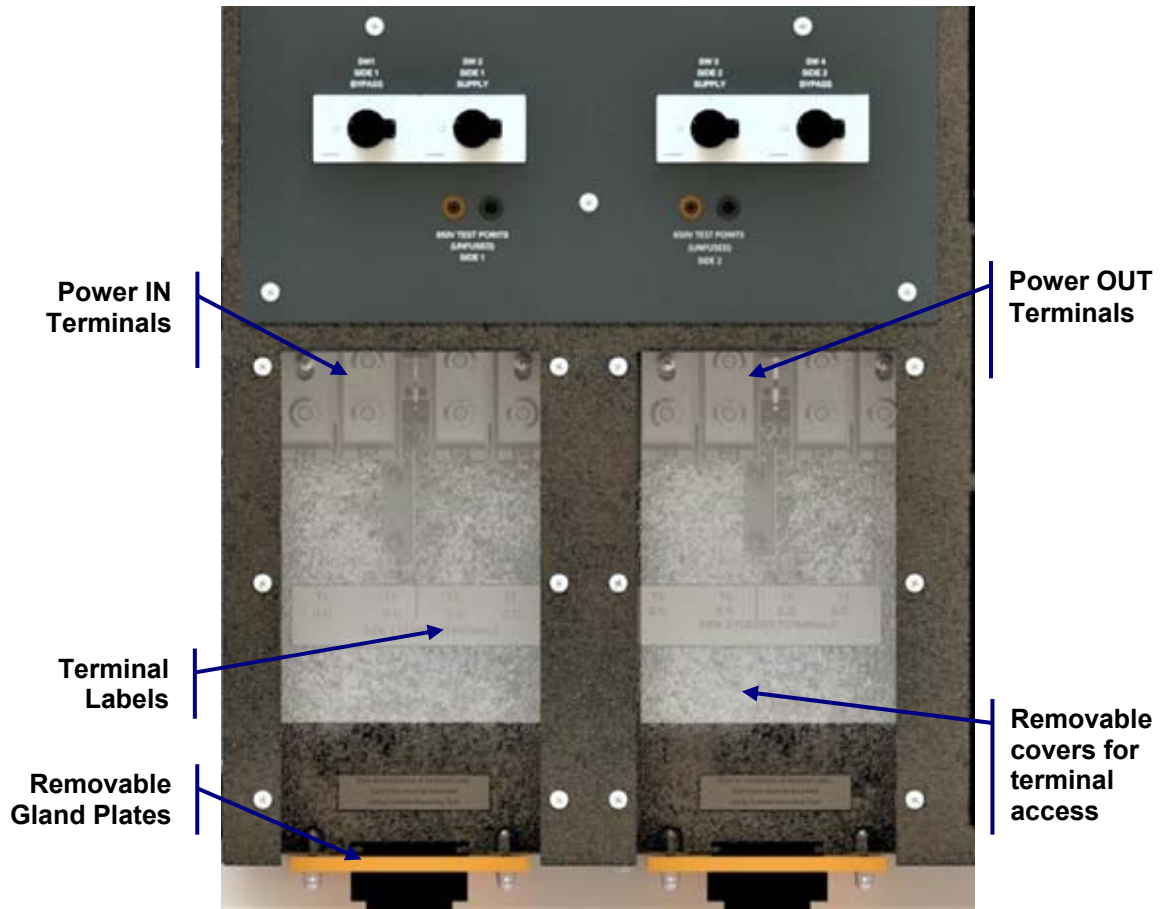

Figure 5: Power In/Out Terminal Arrangement

Note that the Power terminals shown above are of the standard M10 stud type.

The terminal chambers have been designed to accept 2-core or 4-core cables (Copper or Aluminium) up to 120mm².

4 Installation (First fit – with Power OFF)

Installation of Incoming/Loop Power Cables (with Power OFF)

The FSP main front module has been designed to accommodate power cables up to 120mm². The terminal studs are 10mm and the correctly sized cable lugs must be fitted to suit both the cable and the terminal studs.

For recommended insulated reducers and cable glands see Figure 20.

Recommended Installation Sequence for Main Cables:

Note that the steps below should be read in conjunction with the photographs shown in Figure 6 to Figure 16:

1. Measure the length of cable to be stripped & remove outer sheath – see Figure 4.
2. Fit Cable shroud then gland over cable outer sheath– see Figure 7
3. Remove gland plate, fit cable gland & tighten – see Figure 8.
4. Form a V shape into the cable tails so that they line up with the distance between the terminals. Bend tails apart then squeeze together around a suitably sized object – see Figure 9.
5. Fit crimp lugs loosely onto the stud terminals.
6. Install gland plate back onto the bottom of the terminal chamber and mark cables for cutting length & strip length using the crimp lugs as a guide – see Figure 10.
7. Remove gland plate fixings & pull forward for easier access to cut cable tails to length – see Figure 11.
8. Once the cable ends are stripped, the bare copper ends need to be rounded using a rounding tool – see Figure 12. This enable the cable lugs to be rotated easily to orientate correctly with the terminal studs – see Figure 13
9. Push crimp lugs onto cable ends, offer up the gland plate and turn crimp lugs to line up with the terminal studs – see Figure 13.

This is very important as it ensures that there is no stress placed on the stud terminals.

10. Lower gland plate and crimp cable lugs ensuring that the correct orientation is maintained – see Figure 14.
11. Refit gland plate, tape over crimp lugs, install lugs onto terminals, fit washers/nuts & tighten – see Figure 15.
12. Refit terminal protective touch covers – see Figure 16
13. Install the correct sized cable clamp to the cable clamping bar located in the bottom of the enclosure.



Figure 6: Measure & Strip Cable



Figure 7: Fit Shroud followed by Gland onto Stripped Cable



Figure 8: Installed Cable into removed Gland Plate



Figure 9: Forming Cable V shape



Figure 10: Cable length marked ready for cutting



Figure 11: Cable cut to length



Figure 12: Rounding Cable ends using tool



Figure 13: Orientation of crimp lugs with the terminal studs



Figure 14: Crimping Cable Lugs



Figure 15: Tape crimps & terminate cable



Figure 16: Final installation of terminated cables

General Notes on Cable Installation

- There should not be any undue stress or twisting forces on the cable terminals. The cables should be formed, rounded & crimped correctly to avoid this.
- Figure 16 shows that the tails can be crossed if they are the wrong way around once the cable is stripped.
- Both cable glands & cable clamps must be fitted to ensure a robust installation.

4.1 Installation of Internal Hybrid Transformer Primary Circuits Wiring

Terminals are provided for connection of the internal transformer primary wiring within each of the FSP Functional Supply Output Modules.. The wiring is connected to the terminals which are located at the bottom of each output module (functional “way” compartment) – See Figure 17.

The FSP output module fuses and terminals are numbered to correspond with the electrical schematic diagram for the relevant model. The electrical schematic diagram (which matches the model being installed) must be consulted before terminations are carried out to ensure the correct connections are made.

The bottom of each output way contains a clearance hole for 25mm conduit fitting to be installed to carry (and protect) the wiring to its destination (transformer or other 650V supply).

It is essential that the corresponding functional circuit isolator is OFF (and locked) and fuses are removed **before** the functional terminals covers are removed.

Once Isolation has been carried out, it is essential that a proved* voltage indicator is used to recheck that all electrical equipment is dead prior to any works being undertaken.

* It is recommended to use a proving device with the voltage indicator to check for correct operation both before and after checking that the equipment to be worked upon is dead.

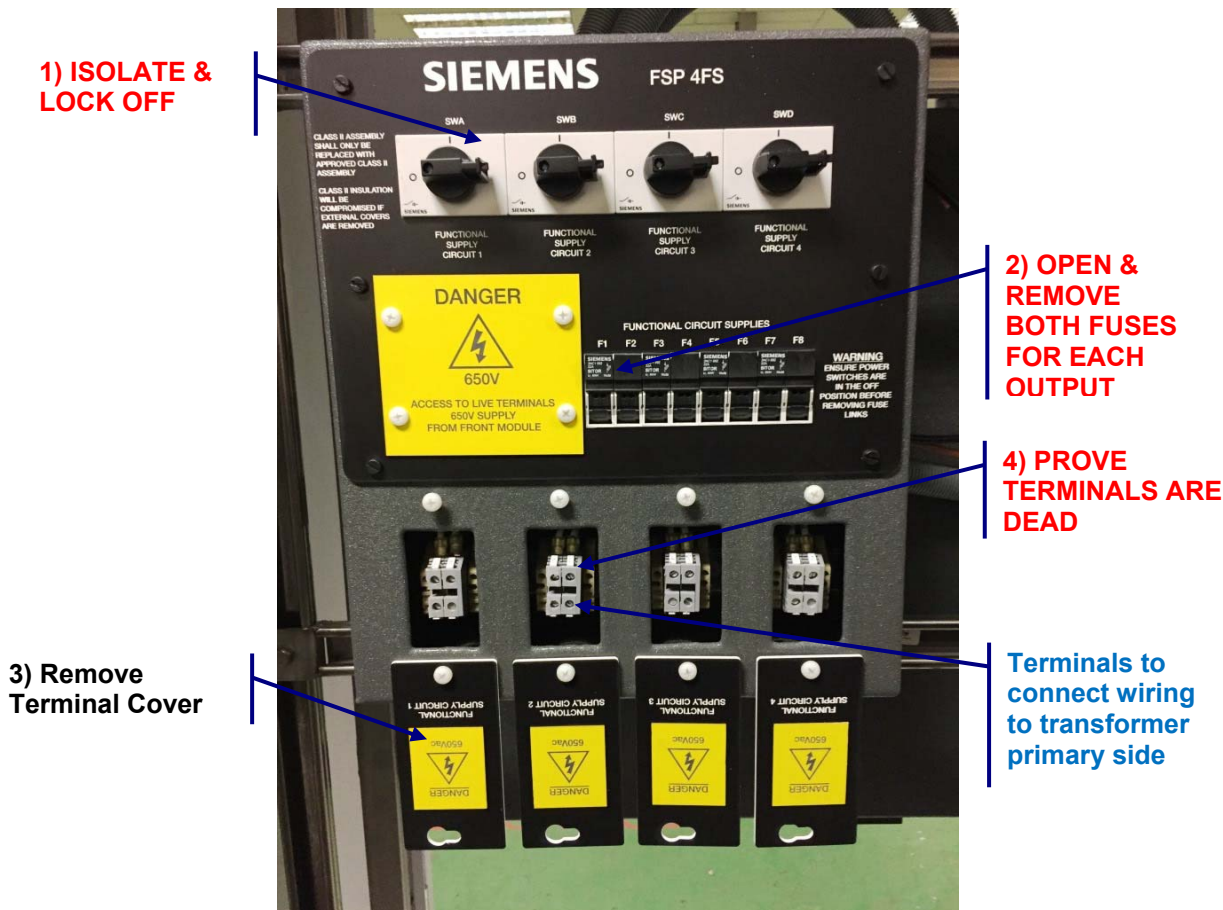

Figure 17: Termination of Hybrid Transformer Primary Feed Cables

Prior to connection of the wires for each functional circuit, the above Safety Precautions MUST be carried out.

4.2 Installation of Functional Load Circuits (650V) External Wiring

Outgoing supplies required at 650V which do not connect to internal transformers can be taken from the remaining outgoing modules.

Each outgoing module houses an isolator, two fuses and two outgoing terminals, the latter of which are provided for connection of the functional circuits wiring. The outgoing wiring is connected to these terminals which are located inside the bottom compartment (under the removable cover) of each outgoing module– see Figure 18.

The FSP Modules fuses and terminals are numbered to correspond with the electrical schematic diagram for the relevant model. The electrical schematic diagram (which matches the model being installed) must be consulted before terminations are carried out to ensure the correct connections are made. See drawing references in Section 1.4

The bottom of each output way contains a clearance hole for 25mm conduit fitting to be installed to carry (and protect) the wiring to its destination (transformer or other 650V supply).

It is essential that the corresponding functional circuit isolator is OFF (and locked) and fuses are removed **before** the outgoing module terminal cover is removed.

Once Isolation has been carried out, it is essential that a proved* voltage indicator is used to recheck that all electrical equipment is dead prior to any works being undertaken.

* It is recommended to use a proving device with the voltage indicator to check for correct operation both before and after checking that the equipment to be worked upon is dead.

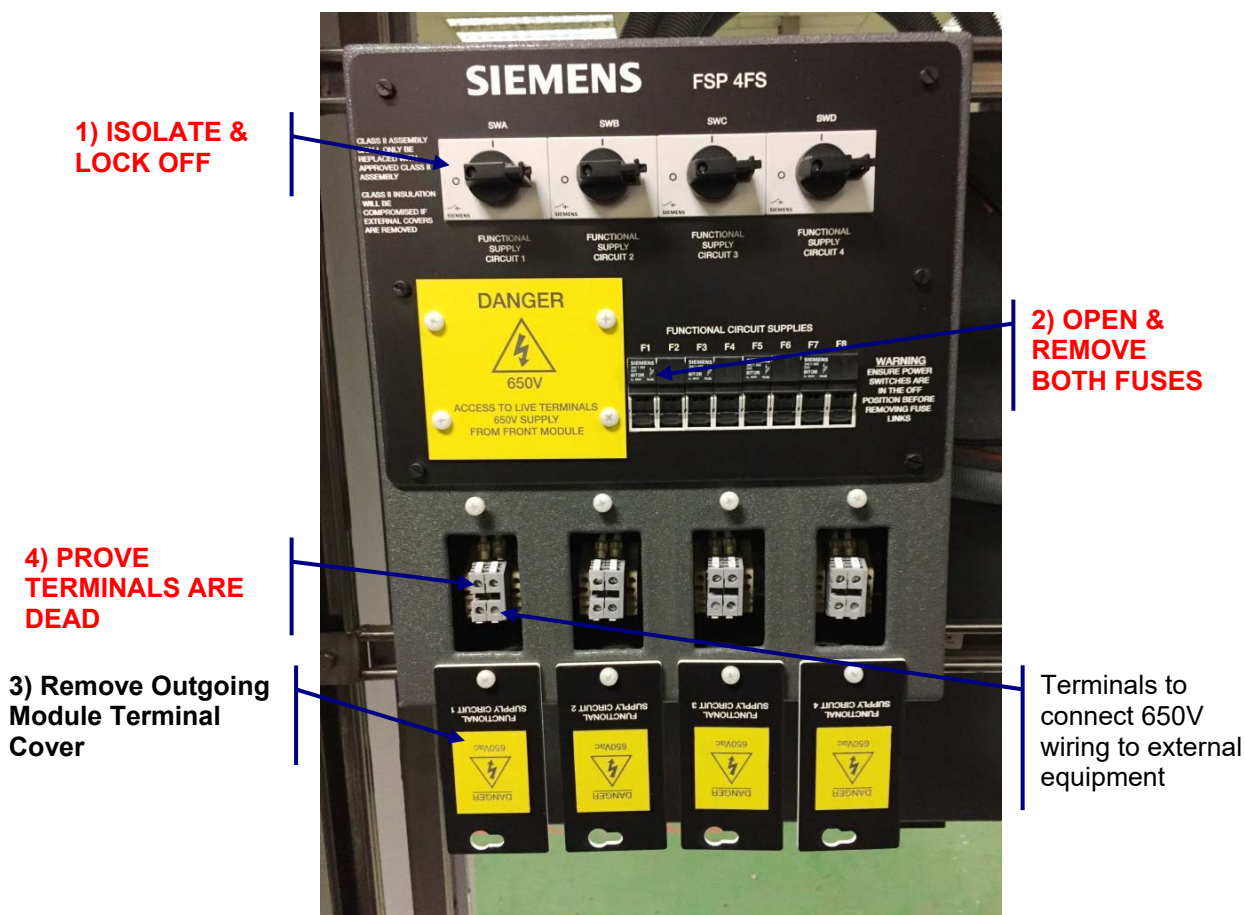

Figure 18: Termination of External Loads Feed Cable

Prior to connection of the wires for each functional circuit, the above Safety Precautions MUST be carried out.

All fuses installed into the FSP fuse holders MUST be rated to 690VAC

4.2.1 Terminals for Functional Load Circuits (650V) External Wiring

The terminals installed within the outgoing modules are of the screw compression clamp type as per the type listed below:

- Entrelec ABB M10/10

The M10/10 terminals are designed to accept the following wire sizes:

- Stranded wire from 0.5mm² up to a maximum of 10.0mm².
- Solid wire from 0.5mm² up to a maximum of 16.0mm².

Under no circumstances should the incorrect terminal size be used as this could lead to cable damage, terminal damage and/or a reduction in the current rating.

The terminals can easily be changed by following the procedure below:

1. Carry out the isolation & locking off procedure as detailed in Section 4.2. This is numbered 1) to 4) in Figure 18.
2. Undo the nylon top screws & bottom nuts to release the top cover and the clear Perspex cover beneath it. See Figure 18.
3. Remember to test the terminals are dead using an approved voltage tester with proving unit.
4. Loosen the top terminal screw of each terminal and remove the two wires from each terminal. Note that the two wires in the left-hand terminal are coloured BROWN and the two in the right-hand terminal are coloured BLACK.
5. Remove each terminal from the DIN rail using a flat blade screwdriver to release the bottom catch.
6. Replace each terminal with the new size required by attaching them to the DIN rail.
7. Insert & tighten the two BROWN wires into the left-hand terminal and the two BLUE wires into the right-hand terminal.
8. The outgoing cable can now be connected to the bottom screws of the correct size terminals.

4.3 Replacement of Incoming or Outgoing Loop Power Cables (Under Operational Conditions)

The FSP is designed so that the incoming and outgoing loop feeder cable terminals are housed in separated compartments. This allows one cable to be isolated and safely worked on whilst the other is still live and powering the location signalling equipment.

Once Isolation has been carried out, it is essential that a proved* voltage indicator is used to recheck that all electrical equipment is dead prior to any covers removed or works being undertaken.

* It is recommended to use a proving device with the voltage indicator to check for correct operation both before and after checking that the equipment to be worked upon is dead.

The diagram in Figure 19 shows three location cases, each one fitted with FSP modules, to terminate and distribute the 650V ring & local cables. The local transformer feed isolators are not shown in the simplified diagram as the intention here is to focus on replacing the mains feeder loop cables.

Each cable is terminated into one of the FSP main terminal chambers (either Loop IN Terminals or Loop OUT Terminals in the diagram).

The FSP internal busbar (and hence local transformer & other functional circuit feeds) can be powered by any of the following:

- a) The cable connected to the main IN terminals.
- b) The cable connected to the main OUT terminals.
- c) Both cables if they are both live i.e. part of the mains ring.

The status of the internal busbar also depends upon the functional state of the following switches:

- a) Bypass Isolator SIDE 1 (SW1)
- b) Bypass Isolator SIDE 2 (SW4)
- c) Supply (Distribution) Isolator SIDE 1 (SW2)
- d) Supply (Distribution) Isolator SIDE 2 (SW3)
- e) The Automatic Reconfiguration System Unit (if installed) (SW5)

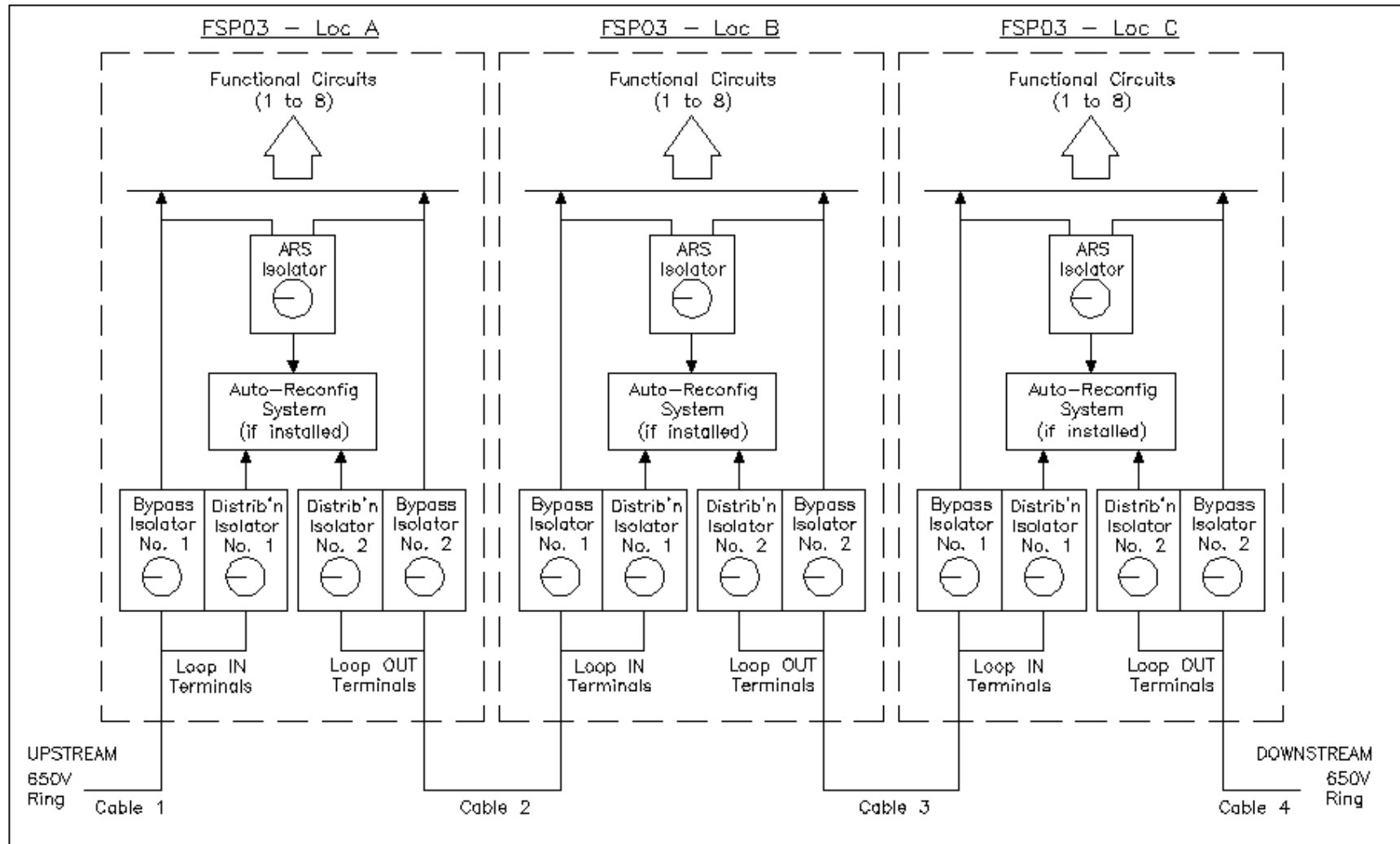

Figure 19: Ring Cable Diagram

Referring to Figure 19, it can be seen that in order to isolate one of the power feed (650V Ring) cables from the FSP then its associated Bypass Isolator and Distribution Isolator MUST BOTH be isolated.

In order to completely isolate any 650v ring cable between two FSP's, the relevant Bypass Isolator and Distribution Isolator MUST BOTH be isolated at EACH end of the cable (4 Isolators in total).

Examples of Isolation Scenarios

In the following example scenarios, please refer to the associated ring cable diagram given in Figure 19.

Note that the Switch Numbers given below refer to the standard FSP Model. The actual Switch numbers may be different depending upon the FSP model installed. It is essential to refer to the correct model wiring diagram before operating any of the FSP isolation switches.

Scenario Example 1 - Complete Isolation of Location B FSP

In order to fully isolate the FSP (at location B) then both cable 2 & cable 3 must be isolated from all sources of supply. This can be accomplished by switching OFF and locking OFF, BOTH of the Distribution & Isolation No.2 switches in Loc A (UPSTREAM of Loc B) and also BOTH of the Distribution & Isolation No.1 switches in Loc C (DOWNSTREAM of Loc B).

It is also essential to check the following:

- a) There is no power being backfed (through the functional switches 1 to 8) from the local transformer supplies.
- b) There is no power being backfed from 650V feeds to other loads from the outgoing module terminals.

Scenario Example 2 - Replacement of Cable 3

Provided the above system is part of a complete closed ring main system (i.e. power fed from both ends) then Cable 3 can be replaced without losing power to any of the three location cases.

In the diagram shown in Figure 19 Cable 3 must first be isolated from all sources of supply by switching OFF & locking OFF BOTH of the Distribution & Isolation No.2 switches in Loc B (UPSTREAM of Cable 3) and also BOTH of the Distribution & Isolation No.1 switches in Loc C (DOWNSTREAM of Cable 3).

In the FSP unit in Loc B the terminal chamber door to "OUT Terms" can now be opened allowing access to the terminations for cable 3. These terminations have a safety shroud

fitted which must be removed to gain full access to the terminal securing bolts once the equipment is proved dead.

The covering safety shroud has two small holes which allow the user to ensure the terminals are dead (by use of a suitable proved test indicator) before removal of the shroud.

Similarly the FSP in Loc C the terminal chamber door to “IN Terms” can now be opened allowing access to the terminations for the other end of cable 3. These terminations also have a safety shroud fitted which must be removed to gain full access to the terminal securing bolts once the equipment is proved dead.

Scenario Example 3 - Replacement of Cable 2

Provided the above system is part of a complete closed ring main system (i.e. power fed from both ends) then Cable 2 can be replaced without losing power to any of the three location cases.

In the diagram shown in Figure 19 Cable 2 must first be isolated from all sources of supply by switching OFF & locking OFF BOTH of the Distribution & Isolation No.2 switches in Loc A (UPSTREAM of Cable 2) and also BOTH of the Distribution & Isolation No.1 switches in Loc B (DOWNSTREAM of Cable 2).

In the FSP in Loc A the terminal chamber door to “OUT Terms” can now be opened allowing access to the terminations for cable 2. These terminations have a safety shroud fitted which must be removed to gain full access to the terminal securing bolts once the equipment is proved dead.

The covering safety shroud has two small holes which allow the user to ensure the terminals are dead (by use of a suitable proved test indicator) before removal of the shroud.

Similarly the FSP in Loc B the terminal chamber door to “IN Terms” can now be opened allowing access to the terminations for the other end of cable 2. These terminations also have a safety shroud fitted which must be removed to gain full access to the terminal securing bolts once the equipment is proved dead.

Scenario Example 4 – Isolation of Rear Section

If it is required to isolate all power from the rear (functional) side of the FSP this can be accomplished by switching & locking OFF all of the following five isolators which are located on the front side:

- Bypass Isolator SIDE 1 (SW1)
- Supply (Distribution) Isolator SIDE 1 (SW2)
- ARS Isolator (SW5)
- Supply (Distribution) Isolator No. 2 (SW3)
- Bypass Isolator SIDE 2 (SW4)
- The Automatic Reconfiguration System Unit (if installed)

4.4 Cable Glands & Insulated Reducers

Class II enclosures cannot use any metal parts that bridge through the insulation material from outside to inside. To this end standard brass (or other metal) cable glands cannot be used in the FSP class II product range.

The FSP class II product range was designed to accept the Network Rail range of insulated reducers & cable gland kits. The FSP main incoming gland plates are normally pre-drilled with a 63mm diameter hole. This is the correct size to fit the standard Network Rail insulated reducer.

These are available in other sizes. The size required should be stated with the order.

For further information, recommended cable glands and insulated reducer kits are shown in Figure 20.



CMP NR737 Insulated Reducer - Compression Glands

NR737 Insulated Reducer/ Gland - Complete Kits

Kit Component List - NR737 Reducer, M63 Back Nut, 1 x M63 Entry Thread Seal, A2 Compression Gland c/w Nylon Washer & PVC Shroud

Reducer/M63 Back Nut	PADS No.	Cleveland Part No	Nylon Washer Seal A	Nylon Washer Seal B	Gland Size	Brass or Plastic
NR/737/20	054/212125	NR737/20/B	M63	M20	20	Brass
NR/737/25	054/212126	NR737/25/B	M63	M25	25	Brass
NR/737/32	054/212127	NR737/32/B	M63	M32	32	Brass
NR/737/40	054/212128	NR737/40/B	M63	M40	40	Brass
NR/737/50	054/212129	NR737/50S/B	M63	M50	50s	Brass
NR/737/50	054/212129	NR737/50/B	M63	M50	50	Brass
NR/737/20	054/212125	NR737/20/P	M63	M20	20	Plastic
NR/737/25	054/212126	NR737/25/P	M63	M25	25	Plastic
NR/737/32	054/212127	NR737/32/P	M63	M32	32	Plastic
NR/737/40	054/212128	NR737/40/P	M63	M40	40	Plastic
NR/737/50	054/212129	NR737/50S/P	M63	M50	50s	Plastic
NR/737/50	054/212129	NR737/50/P	M63	M50	50	Plastic



CMP A2 Brass Compression Glands

Cleveland Part No	PADS No.	CMP Gland Description	Size
CMPA220	054/029246	A2 20 Indoor/Outdoor Brass Compression Gland	20
CMPA225	054/029247	A2 25 Indoor/Outdoor Brass Compression Gland	25
CMPA232	057/029248	A2 32 Indoor/Outdoor Brass Compression Gland	32
CMPA240	054/029249	A2 40 Indoor/Outdoor Brass Compression Gland	40
CMPA250S	054/029250	A2 50S Indoor/Outdoor Brass Compression Gland	50
CMPA250	054/029251	A2 50 Indoor/Outdoor Brass Compression Gland	50



(NR737 c/w A2 Brass Gland Complete Kit illustrated)

Figure 20: Insulated Reducers & Cable Glands

5 Maintenance

All electrical power feeds to the FSP MUST be ISOLATED and LOCKED OFF prior to opening any doors or removal of the enclosure covers.

5.1 Replacement of Components

The internal components can be replaced with new on a like-for-like basis as required. For reference, the part numbers for the components used within the FSP are given in the parts table in section 6.

5.2 Annual Procedure

It is recommended that the following work be carried out yearly:

- General visual inspection as to the condition of the enclosure and components within (including wiring).
- Check that the Electrically Insulated Coating (EIC) does not show any signs of damage and in particular any exposure of the metal base material that this damage caused. See guidance given in Section 5.3
- Check presence & legibility of all I.D. labelling and warning notices.
- Check all cable connections and crimps are secure and do not show any sign of heat/burning.
- Check that all fuses are present and of the correct size (and voltage rating on 650VAC) as detailed on the electrical schematic diagrams.
- Remove, inspect, and re-insert fuses. Check carrier tightness & for signs of any burning.
- Ensure all fixing nuts, washers, bolt covers etc. are present, correct, and tight.
- Check cables and glands box for damage or evidence of water ingress.
- Give the equipment a general clean and remove any build-up of dust/debris using a brush and vacuum fitted with small nozzle.
- Before being returned to service, it is recommended to carry out a full operational check of the isolation switches.

Note that this is a Class II unit and if completely replaced, it must only be replaced by another Class II unit.

5.3 EIC Coating Damage Guidance

As the coating is applied to both the inside and the outside of the inner stainless steel enclosure body, the outer coating can take some acceptable damage before the unit requires replacing.

Note that in order for a person to receive an electric shock (with the box closed) the following simultaneous fault conditions must exist:

- The outer coating must be penetrated/damaged (at least to bare metal).
- The inner coating must be penetrated/damaged (at least to bare metal).
- An internal electrical fault must occur so that a live conductor touches exactly the same area where the inner coating is exposed to bare metal.
- The person must make contact with exactly the same area where the outer coating is exposed to bare metal.

Figure 21 shows a practical guide which has been developed by Henry Williams to help maintenance personnel understand what levels of damage are acceptable and which are not.

As can be seen below the damage guide is split up into three action levels:

Action Level 1

The amount of damage is superficial and does not completely penetrate the outer coating. This level of damage should be noted on the maintenance sheet along with its location. The damage can then be monitored during future inspections to ensure that no further worsening occurs.

It is not recommended to increase the frequency of visual inspections for this level of damage.

Action Level 2

The amount of damage is worse than that in action level 1 in that it does completely penetrate the outer coating. This level of damage should be noted on the maintenance sheet along with its location. The damage can then be monitored during future inspections to ensure that no further worsening occurs.

The unit can be put back into service with an affixed label/notice indicating what damage has been observed.

It is recommended to increase the frequency of visual inspections for this level of damage to ensure that there is no further degradation in the coating.

Action Level 3

The amount of damage is much worse than that in action level 2 in that the enclosure is completely penetrated through both the inner & outer coatings and the stainless steel body. This level of damage should be noted on the maintenance sheet along with its location.

The unit can be put back into service with an affixed warning label/notice indicating what damage has been observed.

It is recommended to replace the unit at the next available opportunity.

Note that the EIC Coating is a NON-REPAIRABLE item



Henry Williams





Henry Williams Ltd
Dodsworth Street, Darlington, DL12NJ
Tel: 01325 482722 Fax: 01325 245220
Web: www.hwilliams.co.uk Email: sales@hwilliams.co.uk



**HENRY WILLIAMS
SAFEBOX APPLICATION**

THE GRID BELOW IS DESIGNED TO PROVIDE A GUIDE AS TO WHAT ACTION IS TO BE TAKEN WHEN CONFRONTED WITH EXTERNAL COATING DAMAGE. ALL SCENARIOS ARE NOT COVERED AND ADVICE SHOULD BE SOUGHT FROM HENRY WILLIAMS LTD IF YOU ARE UNSURE HOW TO PROCEED

E I C DAMAGE GUIDE

<p><u>LIGHT DAMAGE-</u> -SURFACE DAMAGED BUT NO METAL EXPOSED</p>	<p><u>ACTION LEVEL 1</u> DO NOTHING BUT RECORD ANY DAMAGE FOR FURTHER INSPECTION AND MONITORING</p> <p><u>ACTION LEVEL 2</u> UNIT CAN BE RETURN TO SERVICE WITH DAMAGED CLEARLY LABELLED. INCREASE LEVEL OF INSPECTION.</p> <p><u>ACTION LEVEL 3</u> UNIT CAN BE RETURN TO SERVICE WITH DAMAGED CLEARLY LABELLED. REPLACE UNIT AT NEXT AVAILABLE OPPORTUNITY.</p>
<p><u>MEDIUM DAMAGE-</u> -OUTER COATING LAYER BREACHED BUT METAL STILL IN PLACE</p>	
<p><u>HEAVY DAMAGE-</u> -OUTER METAL AND INNER COATING BREACHED</p>	

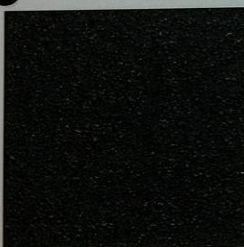
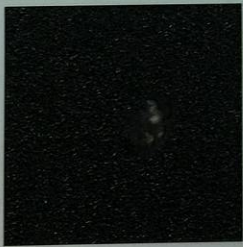







Figure 21: EIC Damage Guide

6 Part Numbers

The table below details the part numbers for the main items used in the FSP Modules along with the description, and supplier for each item.

Description	Supplier	Part Number
3 Pole Isolating Switch – Main (125A)	Siemens	3LD2830-0TK11
3 Pole Isolating Switch – Outgoing (63A)	Siemens	3LD2530-0TK11
Stud Terminals – Main (M300/42.FF)	ABB	1SNA 115 149 R2000
Terminal Partition – Main (ECP42)	ABB	1SNA 113 692 R1700
Outgoing Terminals For 1 – 10mm ² Cables (M10/10)	ABB	0115 120.17
Nut covers (pack of 10)	Henry Williams Ltd.	CON-563

Protection Devices/holders		
IEC Fuse holder (32A)	Siemens	3NC1092
650V Surge Arrestor Module (optional)	PD Devices	Cat: 086/047165